

# DIRIS® A40

## Product presentation



1. Backlit LDC screen
2. Pushbutton for currents and setup wiring correction
3. Pushbutton for voltages and frequency
4. Pushbutton for active, reactive, apparent power and power factor
5. Pushbutton for maximal and average current and power values
6. Pushbutton for harmonics values
7. Pushbutton for energies and hour run meter

Using electrical parameters means using several analog or digital single-function products such as ammeters, voltmeters or watt meters.

DIRIS A40 and A41, with its six direct access keys and LCD displays, helps you use all the parameters in an LV or HV installation.

These parameters can be centralized on a PC or PLC through an RS 485 link using JBUS/MODBUS® or PROFIBUS® DP protocol. The unit is designed so that the installer can easily fit the DIRIS A40 or A41 to the door of a cabinet. To facilitate and optimize the operator's work, the DIRIS A40 and A41 uses one of the most functional principles for integrating communications, metering, harmonics, analog outputs or alarm relays. Simply fit a module to the rear of the casing to add a function.

In addition, DIRIS A40 has a function for correcting connection errors.

### DIRIS® A40



Select a DIRIS®

Auxiliary power supply Us	Catalog number
110 ... 400 VAC / 120 ... 350 VDC (Product Limits)	4825 0A40
110 ... 240 VAC / 120 ... 250 VDC (UL Approved)	

### Optional functions



Select a module

Description	Catalog number
Pulse output	4825 0090
2 configurable outputs impulses (type, weight and duration) for +/- kWh, +/- kvarh and KVAh	
Pulse output + harmonics	4825 0091
2 configurable outputs impulses (type, weight and duration) for +/- kWh, +/- kvarh and KVAh	
Harmonic analysis by row up to 25 and by phase for 3I, In, 3V and 3U	
Communication: RS 485 JBUS/MODBUS	4825 0092
RS 485 link with JBUS/MODBUS protocol (speed up to 38 400 bauds)	
Analog outputs	4825 0093
2 configurable outputs on 3I, In, 3V, 3U, F, +/-ΣP, +/-ΣQ, ΣS and ΣPF <sup>L/C</sup>	
2 modules may be installed, for 4 analog outputs max	
2 inputs – 2 outputs	4825 0094
2 to 6 outputs for monitoring 3I, In, 3V, 3U, F, +/-ΣP, +/-ΣQ, ΣS and ΣPF <sup>L/C</sup> , THD 3I, THD In, THD 3V, THD 3U and hours run or remove control	
Communication PROFIBUS®DP	4825 0096
1 module RS 485 and 1 module protocol PROFIBUS®DP (speed up to 1.5 Mbauds)	
Memory	4825 0097
Storing P+, P-, Q+, Q- values with internal/external synchronisation signal (5, 8, 10, 15, 20 and 30 minutes during 31 and 62 days)	
Storing last 10 time-stamped alarms	
Storing min/max instantaneous values for 3I, In, 3V, 3U, F, +/-ΣP, +/-ΣQ, ΣS, THD 3U, THD 3V, THD 3I, THDIn	
Storing last 10 time-stamped voltage dips, surges and outage (EN 50 160)	
Storing average values according to synchronisation signal for 3U, 3V and F	

## Technical characteristics

Current measurement on inputs (TRMS)	
CT primary	10 000 A
CT secondary	1 and 5 A
Measurement range	0 ... 11 kA
Input consumption	≤ 0.1 VA
Measurement updating period	1 s
Accuracy	0.2 %
Sustained overload	6 A
Intermittent overload	10 In for 1 s
Impulse withstand voltage	4 kV
Voltage measurement (TRMS)	
Direct measurement between phases	18 ... 500 VAC
VT primary	500 000 VAC
VT secondary	60, 100, 110, 115, 120, 173, 190 VAC
Frequency	50 / 60 Hz
Input consumption	≤ 0.1 VA
Measurement updating period	1 s
Accuracy	0.2 %
Sustained overload	760 VAC
Current-voltage product	
Limitation for 1A CT	10 000 000
Limitation for 5A CT	10 000 000
Power measurement	
Measurement updating period	1 s
Accuracy	0.5 %
Power factor measurement	
Measurement updating period	1 s
Accuracy	0.5 %
Frequency measurement	
Measurement range	45 ... 65 Hz
Measurement updating period	1 s
Accuracy	0.1 %
Energy accuracy	
Active (according to IEC 62053-22)	Class 0.5 S
Reactive (according to IEC 62053-23)	Class 2

Auxiliary power supply	
AC voltage	110 ... 400 VAC
AC tolerance	± 10 %
DC voltage	120 ... 350 VDC / 12 ... 48 VDC
DC tolerance	± 20 % / - 6 ... + 20 %
Frequency	50 / 60 Hz
Consumption	≤ 10 VA
Inputs	
Number	2 ... 6
Power supply	10 ... 30 VDC
Minimum signal width	10 ms
Minimum length between 2 impulses	18 ms
Type	phototransistor
Outputs (alarms / control)	
Number of relays	2 ... 6
Type	230 VAC - 6 A - 1 150 VA
Outputs (pulsed)	
Number of relays	2
Type	100 VDC - 0.5 A - 10 VA
Max. number of operations	≤ 10 <sup>8</sup>
Outputs (analog)	
Number of outputs	2 ... 4
Type	isolated
Range	0 / 4 ... 20 mA
Charging resistance	600 Ω
Maximum current	30 mA
Communication	
Link	RS485
Type	2 ... 3 wires half duplex
Protocol	JBUS / MODBUS® in RTU mode
JBUS / MODBUS® speed	1400 ... 38400 bauds
Protocol	PROFIBUS® DP
PROFIBUS® DP speed	9.8 kbauds ... 1.5 Mbauds
Operating conditions	
Operating temperature	- 10 ... + 55 °C
Storage temperature	- 20 ... + 85 °C
Relative humidity	95 %

## Dimensions (in / mm)

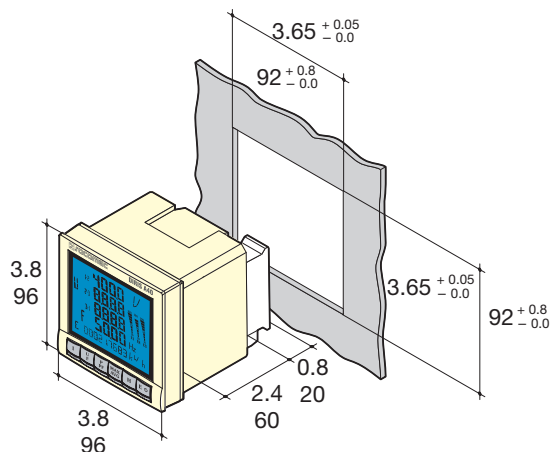

Type	panel mounting
Dimensions H x W x D	96 x 96 x 60 mm
Case protection rating	IP 30
Front protection rating	IP 52
Display type	LCD
Terminal block type	fixed or pull-out
Voltage and other connection section	0.2 ... 2.5 mm <sup>2</sup>
Current connection section	0.5 ... 6 mm <sup>2</sup>
Weight	400 g

## Terminal blocks

### DIRIS A40

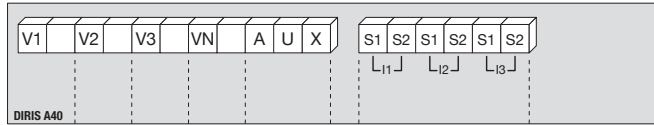

S1 - S2: current inputs  
 AUX: auxiliary power supply  $U_s$   
 V1, V2, V3 & VN: voltage inputs

### Communication module

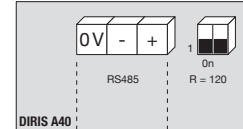

RS485 link  
 R = termination resistance

### Metering module

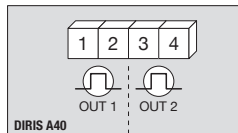

1 - 2: pulse output no. 1  
 3 - 4: pulse output no. 2

### Analog output module 2 inputs / 2 outputs module

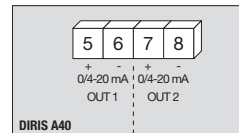

5 - 6: analog output n° 1  
 7 - 8: analog output n° 2

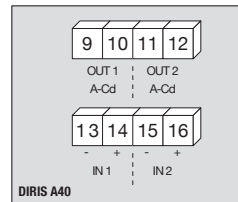

9 - 10: relay output no. 1  
 11 - 12: relay output no. 2  
 13 - 14: opto input no. 1  
 15 - 16: opto input no. 2

### Memory module

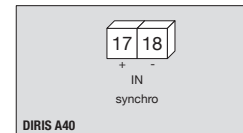

17 - 18: synchronization input

## Connections

Recommendation: when disconnecting the DIRIS, the secondaries of each current transformer must be short-circuited. This operation can be carried out automatically from a product in the Disconnect Switch catalog, PTI, please consult us.

### Low voltage balanced network

- 3/4 wires with 1 CT
- Single phase
- Two phases

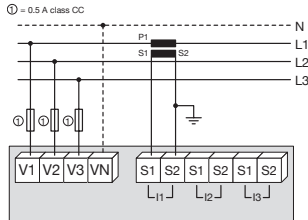

The use of 1 CT reduces by 0.5 % the accuracy of the phase whose current is determined by vector calculation.

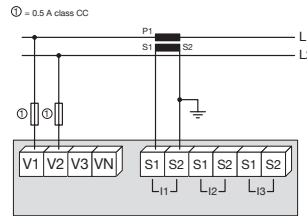
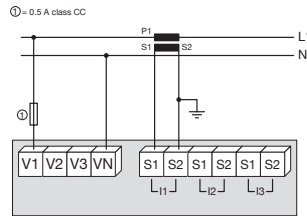

### Low voltage unbalanced network

- 3/4 wires with 3 CTs
- 3 wires with 2 CTs
- 3 wires with 2 CTs

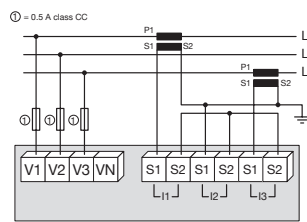
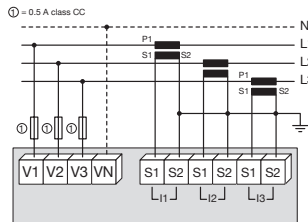

The use of 2 CTs reduces by 0.5 % the accuracy of the phase whose current is determined by vector calculation.

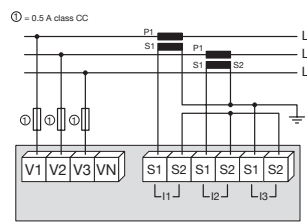

The use of 2 CTs reduces by 0.5 % the accuracy of the phase whose current is determined by vector calculation.

### Other information

- Communication via RS485 link
- Voltage transformer connection for HV networks
- AC or DC voltage auxiliary power supply

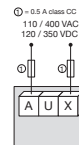
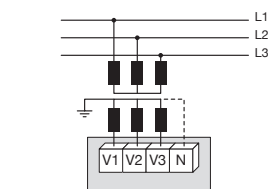
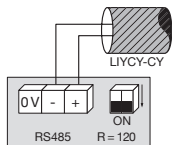

It is recommended that the auxiliary power supply be protected by the use of 0.5 A class CC fuses.